

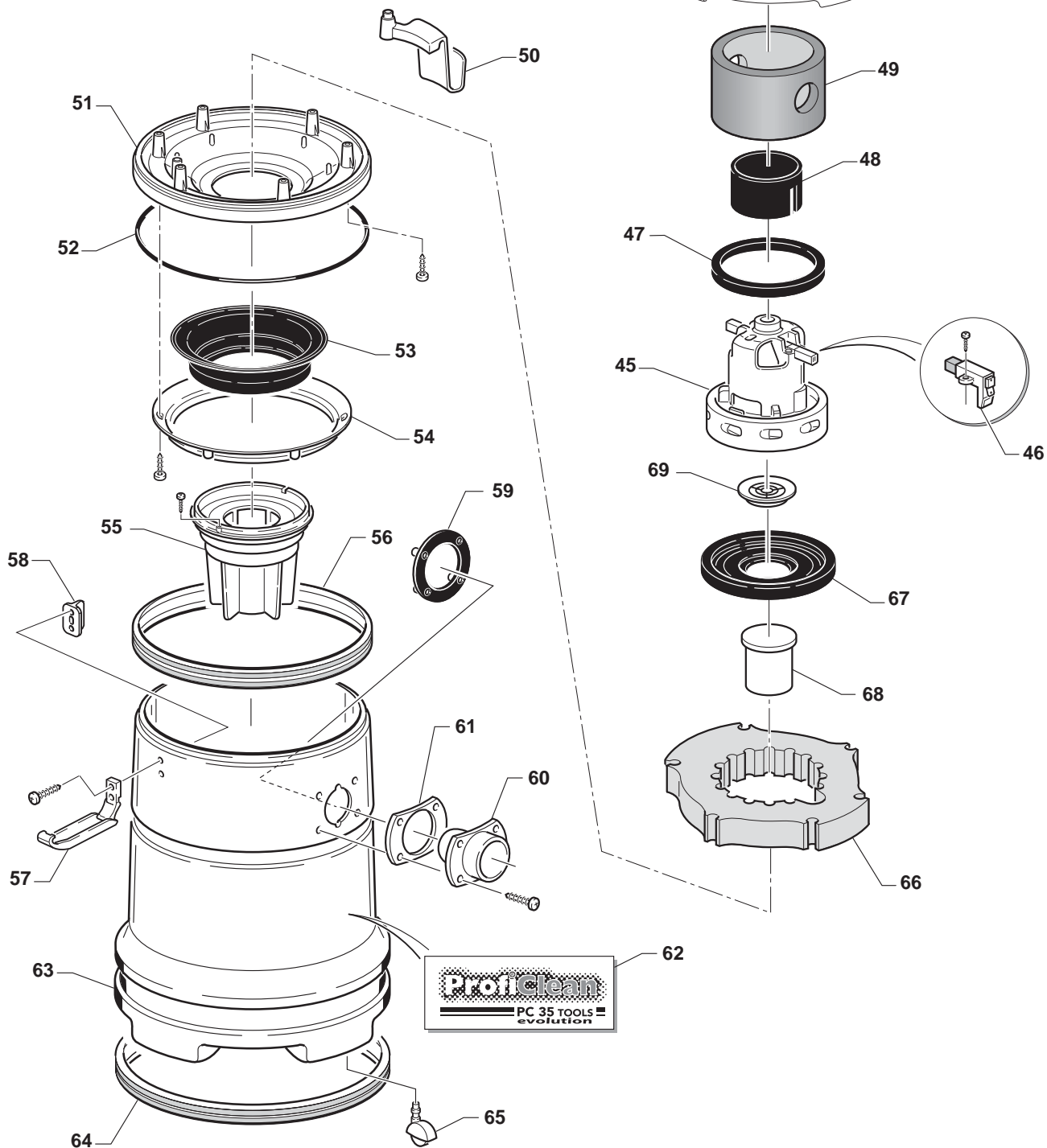

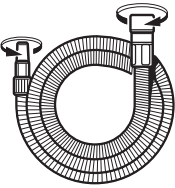

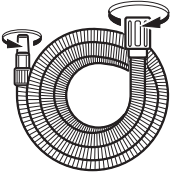



Vedi pag. 1/2
See page 1/2



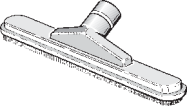
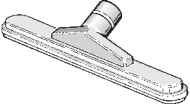
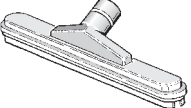



**Accessori
Accessories**

				
80	81	82	83	84
				
85	86	87	88	89
				
90	91	92	93	94

**Accessori opzionali
Optional accessories**

95	96	97	98	99
100	101	102	103	104

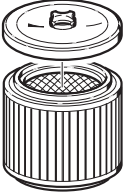
**Sistemi filtranti
Filter systems**

				
105	106	107	108	109
110	111	112	113	114

